

AN EFFICIENT ANALYTICAL STUDY ON UNS S32760 STRESS ANALYSIS OF NOTCHED SUPER DUPLEX STAINLESS STEEL

¹Dr.Ch.Srinivas, ²D.Vijay Kumar, ³K.Sudharshan, ⁴G.Ranapratap Reddy

¹Associate Professor, ^{2,3}Assistant Professor, ⁴UG Student, , ^{1,2,3,4}Department Of Mechanical Engineering, Vaageswari College Of Engineering - Karimnagar

ABSTRACT

The current project aims to investigate how the notch shape affects the tensile strength of the superb duplex stainless steel UNS S32760. The strain-lifestyles curve for the chosen fabric is initially calculated using Finite Element Method and empirical methodologies. Afterwards, an experimental inquiry is conducted to assess the consequences. The investigations' scope includes measuring the strain on the experimentally chosen material. Research on the effects of the notch parameters (depth, breadth, and notch crucial angle) on the tensile strength and fatigue life of the aforementioned material is also included in the scope. The structure of the tests uses project notches of various parameters using response floor methods to quantify the impact of notch parameters on fatigue lifetimes. Prediction of the effect of any notch variation at the fatigue lifestyles is likewise completed the use of regression analysis.

Keywords: Keywords: Fatigue Life, fatigue analysis, Fatigue failure, Low Fatigue analysis, S-N curve, ϵ -N curve, Super Duplex Stainless Steel, UNS S32760.

INTRODUCTION

Fatigue failure is the degradation of a material brought on by cyclic stress, which results in recent and localized structural damage that may be seen with the use of a cracking boom. A crack that has already started will get smaller with each load cycle until it reaches a significant length, at which point the pressure depth aspect of the crack causes fast propagation and often complete fracture of the component or form. Steel fatigue originated from the traditional association of fatigue with metal system failure.

Ship systems are exposed to many different cyclic mass variations from wind, waves, and load operations, which might cause fatigue damages in them. Fatigue cracks usually arise in advance than expected in numerous places of ships/different marine systems which significantly have an effect on their wellness and operations. During the last decades, there has been a speedy boom within side the international delivery markets and this created the want for accelerated length of ships. The improvements in production technology enabled this with the aid of using novel versions of stainless steels with better electricity to weight ratio in ships. The OOCL Hong Kong is the primary deliver ever to surpass the 21,000 TEU mark. With accelerated dimensions, the deliver's shape is liable to greater risk from the tidal masses that may bring about fatigue damages and this will venture the deliver's layout and safety. Hence, deliver systems must be designed with good enough fatigue electricity banking upon general policies and procedures. Though the deliver systems are constructed primarily based totally on general policies and pressure-primarily based totally strategies, screw ups are nonetheless determined because of fatigue. Due to the massive uncertainties like numerous wave environments, unsure hydro-dynamic repetitive masses, pressure concentrations etc. concerned with inside the fatigue layout procedure of ships, fatigue cracks arise a great deal in advance than expected. One of the motives for the poor fatigue layout of ships is the absence/ inadequate utilization of stress-primarily based totally strategies in the course of fatigue studies. The presence of unexpected geometry changes, notches and cracks at the surface additionally want to receive weightage in the course of the fatigue layout. Hence layout of deliver systems for fatigue loading is inadequate with out stress-primarily

based totally fatigue analysis. The modern studies targets at investigating the fatigue lifestyles/ electricity of grades of marine steels; UNS S32760 the use of stress primarily based totally approach. The scope of the studies encompasses, investigating the low cyclefatigue lifestyles of the figure material of the above versions of steels and their similar. The scope similarly consists of research at the impact of notch parameters (depth, width and notch principal angle) upon the fatigue lifestyles of the above stated steels. Effect of notch parameters at the fatigue lifestyles is quantified the use of layout of experiments with the aid of using project notches of various parameters by Taguchi L9 orthogonal array.

LITERATURE REVIEW

Fatigue is slow, restricted, and everlasting failure that takes place in a thing uncovered to fluctuating stresses which might be frequently a whole lot decrease in value than the fabric's tensile power. Fatigue loading may also first of all create cracks and reason fracture after an good enough number of fluctuations. Fatigue failure consists of 3 stages [1]: • Preliminary fatigue failure and initiation of crack. • Propagation of the crack to a vital size. • Ultimate abrupt fracture with inside the residual cross-section. Damage because of fatigue loading is instigated with the aid of using the simultaneous acts of cyclic pressure, plastic stress and tensile pressure. If any of those is absent, fatigue crack does now no longer crop up and propagate. The plastic stress that is a effect of cyclic pressure reasons the crack and the tensile pressure makes the crack to propagate. Vigilant quantification of lines depict that plastic lines alevn though microscopic in nature should exist even at decrease magnitudes of pressure wherein the stress if discovered at macroscopic stage seem like definitely elastic. Even alevn though compressive stresses do now no longer reason fatigue failure, compressive masses may also crop up nearby tensile stresses [2]. Fatigue power of steels is usually taken into consideration to be proportional to hardness and tensile power, however this generalization might not be authentic always. Processing operations, fabrication methods, warmness/floor treatments, completing done, and provider situations profoundly effect the behaviour of a cloth uncovered to cyclic loading. Forecasting the fatigue existence of a thing is complicated as substances are generally touchy toward minor versions in loading pattern, pressure concentrations etc.

Terminology in Fatigue

Stress Range: The stress range, σ_r is given by the maximum stress minus the minimum stress in a cycle;

$$\sigma_r = \sigma_{max} - \sigma_{min} \quad (\text{Equ. 2.1})$$

Alternating Stress: The alternating stress is given by 0.5.

$$\sigma_a = \sigma_r / 2 = \sigma_{max} - \sigma_{min}$$

(Equ. 2.2)

Mean Stress: The mean stress is the mean of the maximum and minimum stress in a cycle:

$$\sigma_m = (\sigma_{max} + \sigma_{min}) / 2$$

Stress Ratio: The stress ratio R is given by the ratio of **σ_{max} and σ_{min}** ;

$$R = \sigma_{max} / \sigma_{min} \quad (\text{Equ. 2.3})$$

Amplitude Ratio: The amplitude ratio A is the ratio of **σ_a and σ_m** ;

$$A = \sigma_a / \sigma_m = 1 - R / 1 + R \text{ (Equ. 2.4)}$$

Effect of Notch on the Fatigue Life of Steels

In case of pointed notches, the „notch sensitivity“ K_f / K_t raises along with the notch size. For as-received steels, the notch sensitivity is much superior at a stress ratio $R = -1$ when compared to $R = 0$. This means that, at $R = -1$, the as-received steels are less sensitive to notches compared to the heat-treated counterparts. For a given notch size, tempering temperature does not have considerably influence on notch sensitivity in the case of heat-treated steels. Further, notch sensitivity and ductility from true fracture strain cannot be related through any direct relation. M. Makkonen et. al. studied the fatigue overall performance of tempered metal specimens with grooves and got here to a end that a unmarried approach can not be used by myself to estimate the staying power limits of sharp notches and blunt notches. In the case of very sharp notches, the plastic pressure even on the staying power restrict became widespread, and that have to be accounted for. In case of blunt notches in which the plastic pressure became insignificant, staying power restrict became exactly predicted with the combination of statistical and geometric length results. The statistical length impact itself supplied sufficiently unique solutions for engineering purposes. Fatigue restrict of sharp notches have to be approximated through a way that considers the truth that, because the notch's radius of root reduces, the fatigue/staying power restrict actions closer to a price this is attained as follows

METHODOLOGY Types of stainless steels

Stainless steels are typically divided into 4 groups: Austenitic. Most common types of stainless steels are comprised in the austenitic group. Austenitic stainless steels incorporate Higher degrees of chromium, molybdenum and nickel. they are in particular versatile and are known for super strength and malleability.

Ferritic. ferritic stainless steels typically are low carbon content material of much less than 0.1%. Containing between 10.5% and 30% chromium, Ferritic stainless steels are magnetic and are generally selected for the temperature oxidation and stress corrosion cracking resistance.

Duplex. Duplex stainless steel combines the austenitic with the ferritic, leading to a metal that is stronger than both: this higher strength can cause considerable weight reductions. Its high resistance to corrosion, even in demanding environments, make it ideal for use in marine applications.

Martensitic. Structurally like ferritic stainless steel but with an increased carbon content ($< 1.2\%$), martensitic stainless-steel are mostly hardened to a large degree. **Super Austenitic Stainless Steel**

Property	UNS S32760	
	Catalogue	Actual
Modulus of Elasticity (GPa)	190 - 201	200
Poisson's ratio	0.30	0.30
Brinell Hardness (HBW)	Max 270	201
Tensile strength (MPa)	730 - 930	898

Table: Physical properties of the material		
Physical Properties	Values	Units
Specific Heat (0-100°C)	500	J.kg-1.°K-1
Thermal Conductivity	14	W.m -1.°K-1
Thermal Expansion	16.5	µm/µm/°C
Modulus Elasticity	196	GPa
Electrical Resistivity	8.5	µohm/cm
Density	8	g/cm3

Design criteria

The fatigue specimens were fabricated for strain-controlled fatigue testing as specified by ASTM E606 standard. The gauge length is 15 mm for the specimen UNS S32760 undertaken and the drawing of the specimen is presented in Figure

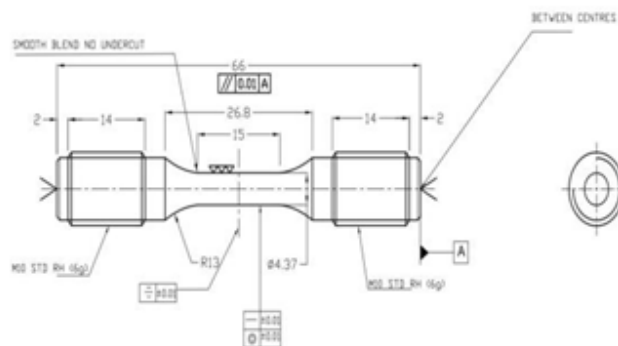

Fig. : Standard Fatigue Specimen.

Specimen Fabrication

The material UNS S32760 was bought in the form of 2M long solid rods of 14mm diameter. These rods were transported from Mumbai to Hyderabad and then sent for fabrication. These rods were first sent to test the straightness of the material to check the dimensions and any deformations and kinks in the material.



The specimens are fabricated on a CNC Lathe Machine (Figure) and the notches are made using a 4th axial CNC Milling machine. The CNC operations used were facing, turning and chamfering. These operations were all calibrated through the CNC program.

The specimens are fabricated on a CNC Lathe Machine (Figure) and the notches are made using a 4th axial CNC Milling machine. The CNC operations used were facing, turning and chamfering. These operations were all calibrated through the CNC program.



Fig: Super Jobber CNC Lathe Machine that was operated to fabricate un-notched and notched specimens.



Fig. : Specimen After complete fabrication on one side



Fig.: Specimen after complete fabrication on both sides without the notch.

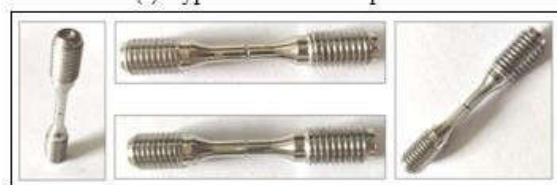

fig: Different views of a typical notched specimen

2. EXPERIMENTATION Fatigue Testing

Low cycle fatigue testing is carried out with a 25

KN capacity Servo Hydraulic Nano UTM that is of ITW – BISS make (figure 4.1). strain controlled fatigue

testing is undertaken as it is the most suitable method in particular when there are notches grooved on geometry. to two repeats are executed for one experimental situation as consistent with ASTM E606 standard and the average of the nearest values is offered as fatigue life for error reduction and consistency within the results.



Fig. : Servo Hydraulic Nano UTM (Capacity: 25 KN) used for fatigue testing

Design of Experiments

Taguchi Technique for Notch Analysis

The three elements chosen for Taguchi evaluation of notch fatigue strength together with their high, medium and low levels are referred to in table 4.1. The experimental matrix given in table 4.2 is a 9-trial orthogonal array (OA) of Taguchi matrix i.e. L9. This OA provides complicated enough array to illustrate the amount of confounding that can occur in an experiment.

Table 4.1 Factors chosen and their levels					
Factor	Notation	Units	Levels		
			Low	Medium	High
Width	W	Mm	1	1.25	1.5
Depth	D	Mm	0.5	0.75	1
Notch Central Angle	A	degrees	120°	240°	360°

Table 4.2 Notch parameters for fatigue analysis						
Run	Coded Values			Absolute Values		
	W	D	a	w (mm)	d (mm)	a (degrees)
1	-1	-1	-1	1	0.5	120°
2	-1	0	0	1	0.75	240°
3	-1	1	1	1	1	360°
4	0	-1	0	1.25	0.5	240°
5	0	0	1	1.25	0.75	360°
6	0	1	-1	1.25	1	120°
7	1	-1	1	1.5	0.5	360°
8	1	0	-1	1.5	0.75	120°
9	1	1	0	1.5	1	240°

It is also included in the output response as per Taguchi L9 orthogonal.

The experimental outcomes are analyzed by using the Chauvenet’s criterion for their deviations in a way which illustrates the percentage contribution of every parameter with 0% error. by means of using additive model, the difference because of the inclusion and exclusion of the fictitious parameter (p) is estimated. With this perturbation, the correction values are computed for the experiment under consideration. The corrections are added/ subtracted from the estimated values to reach at the lower and upper bounds. The regression equation developed from this method is used to estimate the fatigue life of complete factorial matrix along side the lower and top bounds of the fatigue life.

EMPIRICAL METHODS

Different empirical methods are adopted to estimate the fatigue/endurance limit and to approximate the „Stress (vs) Fatigue Life“ and „Strain Amplitude (vs) Fatigue Life“ curves for the chosen materials. Marin’s equation is employed to find the endurance limit. Further, a method proposed by Shigley is employed to approximate the „Stress (vs) Fatigue Life“ curves. Strain based fatigue life prediction is done using the Muralidharan-Mansion method and the „Strain Amplitude (vs) Fatigue Life“ curves are approximated for the chosen materials.

Table : Data for interpolation of k_c

S_x (MPa)	k_c
344.738	0.907
689.476	0.859
1034.21	0.822
1378.95	0.814

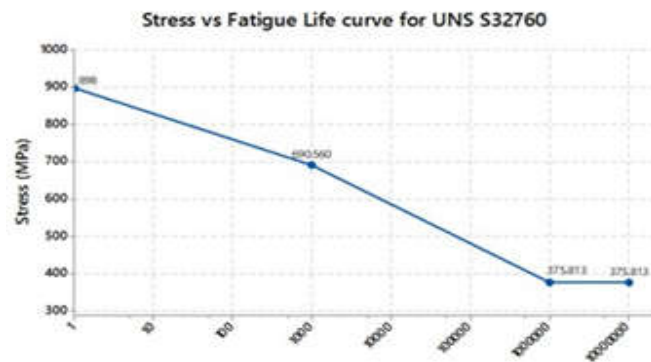

Graph: Stress vs Fatigue Life curve for UNS S32760 The fatigue life of the materials and their weldments undertaken are computed at different strain amplitudes using the Muralidharan-Mansion method and the results are presented in Table

Table : Fatigue Life in cycles at various Strain amplitudes (%)	
Strain Amplitude % (i.e. Strain Amplitude x 100)	
UNS S32760	Fatigue Life in cycles
0.602	1000
0.534	2000
0.494	3000
0.466	4000
0.445	5000
0.429	6000
0.416	7000
0.405	8000
0.395	9000
0.387	10000
0.38	11000
0.374	12000
0.368	13000
0.363	14000

Table : depict the „Strain amplitude (vs) Fatigue Life“ curves developed employing the Muralidharan-Mansion method for the material.

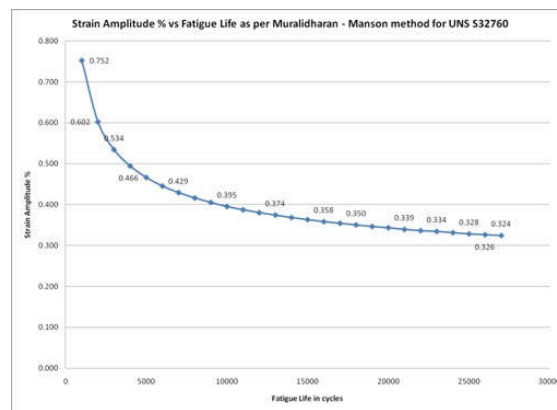

Graph: Strain Amplitude (vs) Fatigue Life plot for UNS S32760

Fatigue Analysis Using Finite Element Approach The fatigue tool available in ANSYS 18.1 was used to approximate the fatigue life in cycles for the materials UNS S32760 steel. 3-D model of the ASTM E606 standard Fatigue specimen was created in CREO 3.0 and exported to ANSYS 18.1 as IGES file. Discretization was carried out using Tetrahedron elements maintaining mesh refinement level as three. Finite Element Fatigue Analysis was carried out on the standard fatigue specimen (Figure 4.2) to find out the endurance limit and subsequently to plot the „Stress (vs) Fatigue Life“ curve. Smith – Watson – Topper method of the Strain – Life approach was adopted for the analysis since it provides a conservative answer in comparison to the Morrow’s approach.

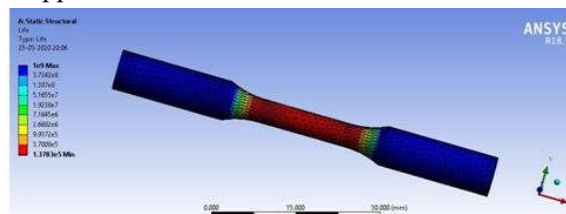

Figure : Fatigue Life in cycles

Finite element fatigue runs are carried out for 40 different loadings and the stress (vs) fatigue life curve is

plotted from respective stress and fatigue life values. Table 5.3 encompasses the stress and fatigue life values and the curve is depicted in Figure 45.3. The magnified view of the low cycle fatigue region of the stress (vs) fatigue life curve is shown in Figure 5.4. The endurance limit is found to be 321.45 MPa for as it is the stress value obtained at a fatigue life of around 10^6 cycles.

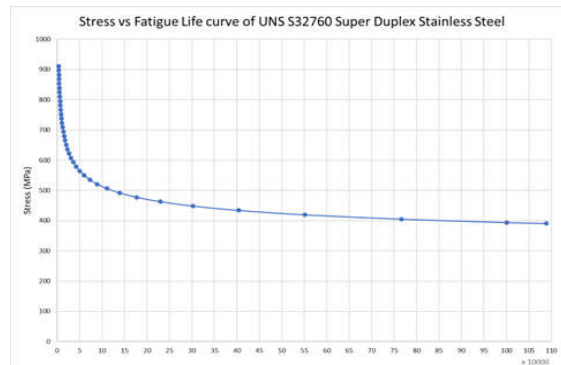

Fig : Stress (vs) Fatigue Life curve for UNS S32760 fatigue strength reduction of bearing steel in the very high cycle regime,

Impact of Notch Geometry on the Fatigue Life Specimens without notch and with various types of notches as per Taguchi L9 orthogonal array were fabricated using a CNC Lathe. Both parent material and welded samples were used to fabricate these specimens based on the scenario. Strain controlled fatigue runs were executed with 0.3% strain amplitude on the specimens till there was an appreciable crack observed on the specimen. Fatigue runs were initially undertaken on the specimen without any notch on its surface and the fatigue life in cycles was recorded. Thereafter, the fatigue test runs were undertaken for the nine specimens with various types of notch geometries on their surfaces and the fatigue lives were noted.



Figure : UNS S32760 specimens post fabrication



Figure: UNS S32760 un-notched specimen after fatigue failure.

Specimen scenario	Fatigue Life (cycles)		
	Trial 1	Trial 2	Average
UNS S32760 Material	26884	25147	26016

The nine notched specimens after fatigue failure are shown in Figure 5.8 and the results are presented in Table

Run	w	D	a	Fatigue Life (cycles)		
				Trial 1	Trial 2	Average
1	-1	-1	-1	2783	2876	2830
2	-1	0	0	2566	2345	2456
3	-1	1	1	589	650	620
4	0	-1	0	7155	6987	7071
5	0	0	1	1513	1389	1451
6	0	1	-1	2895	2568	2732
7	1	-1	1	2387	2546	2467
8	1	0	-1	4120	3895	4008
9	1	1	0	1267	1018	1143

When the depth of the notch is at the lowest value with the width and notch central angle at their mid values, the fatigue life is observed to be the highest to the tune of 7155 cycles (Run 4), while the fatigue life is observed to be the lowest to the tune of 589 cycles only when the depth of the notch is at the highest value (Run 3) as illustrated in Table .

Coefficient	Estimate	SS	DOF	MS	F
b ₀	2752.722	-	-	-	
b ₁	190.222	651320.889	2	325660.444	0.04325861
b ₂	-874.833	13776000.500	2	6888000.250	0.914957047
b ₃	-559.056	5625776.056	2	2812888.028	0.373645707
b ₄	98.444	174443.556	2	87221.778	0.011585972
b ₅	74.333	99458.000	2	49729.000	0.006605676
b ₆	-194.333	679778.000	2	339889.000	0.045148639
SSR		21006777.000	12		
SSE		37641112.611	5	7528222.522	
SST		58647889.611	17		

The data is subjected to analysis of variance using Yate’s algorithm and the values/ coefficients are presented in Table

Source	SS	DOF	MS	F	% Contribution
w	9949003.11	2	4974501.56	4.00	16.96
d	20782451.44	2	10391225.72	8.36	35.44
a	14250781.44	2	7125390.72	5.74	24.30
SSR	44982236.00	6			
SSE	13665653.61	11	1242332.15		
SST	58647889.61	17			

From the Taguchi analysis it is evident that depth of notch has 35.44%, notch central angle has 24.30% and width of notch has 16.96% impact on the fatigue life of UNS S32760 super duplex stainless steel.

The experimental data is also subjected to Analysis of means (ANOM) and the results are presented in Table

5.9 and plotted in Figure . The grand mean of the results in terms of fatigue life is found to be 2753 cycles. Based on the ranks computed, it is clearly seen that depth of notch is predominant in governing the fatigue life while the width is contributing to a lower extent.

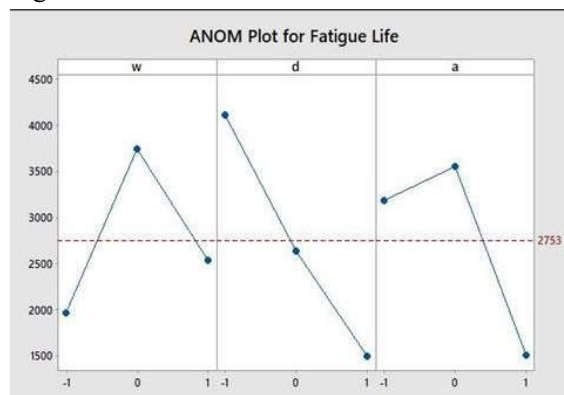

From Taguchi Analysis optimal parameter condition is; w = 0, d = -1 and a = 0 in their coded forms and the absolute values are; w = 1.25 mm; d = 0.5 mm; a = 240° respectively. The predicted optimal fatigue life can be found by the equation,

$$\text{Optimal predicted fatigue life, } f_{\text{optimum}} = m + (m_i - m)$$

where; m = Grand Mean and m_i = Maximum value in

$$\text{each parameter at optimal condition. Therefore; } f_{\text{optimum}} = 2753 + [(3751.17 - 2753) + (4122.33 - 2753) + (3556.33 - 2753)] = 5924 \text{ cycles}$$

Employing the optimal parameter condition an experiment is conducted and it is found that the optimal fatigue life is 6652 cycles and it is in consonance with the predicted value.

At this stage, modified Taguchi method which is based on Chauvenet's criterion is applied for one trial values of the fatigue life and the corrections for the fictitious parameter are obtained as -954.00, -192.33, and 1146.33 respectively.

Parameter	1-mean	2-mean	3-mean	Mean	SS	% Contribution
w	1979.33	3854.33	2591.33	2808.33	5485338.00	18.38
d	4108.33	2733.00	1583.67	2808.33	9586450.67	32.13
a	3266.00	3662.67	1496.33	2808.33	7982064.67	26.75
p	1854.33	2616.00	3954.67	2808.33	6783564.67	22.74
				Sum	29837418.00	100

CONCLUSION

This experimentation of fatigue analysis of the Super Duplex Stainless-steel UNS S32154 has yielded the stress amplitudes and the fatigue lives of the material with different parameters such as notch angles varying from 0° to 360°, and the Notch depths varying from 0.5mm to 1mm, and the notch width varying from 1mm to 1.5mm.

These variations in notches have made an interesting impact on the fatigue life of the material, It was noticed that the notch depth has an vital role in the life of the material, As the notch depth increases, the fatigue life of the material decreases.

Below are the notch parameters that were considered in the experimentation.

S.No	Width (mm)	Depth (mm)	Notch Central Angle
1	1	0.5	120°
2	1	0.75	240°
3	1	1	360°
4	1.25	0.5	240°
5	1.25	0.75	360°
6	1.25	1	120°
7	1.5	0.5	360°
8	1.5	0.75	120°
9	1.5	1	240°

REFERENCES

1. Howard E.Boyer, Atlas of Fatigue Curves, American Society for Metals International, pp. 9, 2006.
2. Bruce Boardman, Properties and Selection: Irons, Steels, and High- Performance Alloys, ASM Handbook, Vo. 1, pp. 673-688, 1990.
3. Ian F.C.Smith, Manfred A.Hirt, A review of fatigue strength improvement methods, Canadian Journal of Civil Engineering, Vol. 12, Issue 1, pp. 166- 183, 2011.
4. Mitchell P.Kaplan, Timothy A.Wolff, Fatigue-Life Assessment, Failure Analysis and Prevention, Vol. 11,ASM Handbook, ASM International, pp. 276-288, 2002.
5. F.C.Campbell, Elements of Metallurgy and Engineering Alloys, ASM International, Vol. 83, Issue 1, pp. 317, 2008.
6. S.Upadhyay, Low Cycle Fatigue and Post Fatigue Tensile Behaviour of a Non-Conventional Austenitic Stainless Steel, M.Tech Thesis, National Institute of Technology, Rourkela, May 2014.
7. X.W.Ye, Y.H.Su, J.P.Han, A State-of-the-Art Review on Fatigue Life Assessment of Steel Bridges, Mathematical Problems in Engineering, Volume 2014,Article ID 956473, 2014.

8. Basquin. O.H, The Exponential Law of Endurance Tests, Proceedings, American Society for Testing and Materials, ASTEA, Vol. 10, pp. 625–630, 1910.
9. T.L.Anderson, Fracture Mechanics Fundamentals and Applications, 3rd Edition, Taylor & Francis, 2005. 10.Walter G.Reuter, Robert S. Piascik, Fatigue & Fracture Mechanics: 33rd Volume, ASTM International, 2002.
11. C.S.Yen, T.J.Dolan A Critical Review of the Criteria for Notch-Sensitivity in Fatigue of Metals, University of Illinois Engineering Experiment Station, Bulletin Series No. 898, Vol. 49, Issue 53, 1952.
12. R.Sunder, Spectrum load fatigue – underlying mechanisms and their significance in testing and analysis, International Journal of Fatigue, Vol. 25, pp. 971–981, 2003.
13. A.Fatemi, L.Vang, Cumulative fatigue damage and life prediction theories: a survey of the state of the art for homogeneous materials, International Journal of Fatigue, Vol. 20, Issue 1, 1998.
14. Ralph I.Stephens, Ali Fatemi, Robert R. Stephens, Henry O. Fuchs, Metal Fatigue in Engineering, 2nd Edition, ISBN: 978-0-471-51059-8, 2000.
15. Richard P.Wool, Fundamentals of Fracture in Bio- Based Polymers, Bio-Based Polymers and Composites 1st Edition, Academic Press, pp. 149-201, 2005.