

# EXTRACTION OF MAXIMUM POWER FROM A SOLAR BASED PV SYSTEM USING FUZZY CONTROLLER BASED MPPT TECHNIQUE

Sandeep Sunkari  
Assistant professor, Dept. of EEE  
CJITS  
Jangaon, Telangana, India

Gujjula Naresh  
Assistant professor, Dept. of EEE  
St.Marys Group  
Hyderabad, Telangana, India

Aroju Naresh  
Assistant professor, Dept. of EEE  
St.Marys Group  
Hyderabad, Telangana, India

## ABSTRACT

The main aim of this project is extraction of maximum power from a sun based pv system using fuzzy controller based mppt technique. Two types of MPPT techniques are focused in this paper i.e. the conventional Perturb and Observation method and fuzzy logic controller. It is seen that the tracking speed of fuzzy logic controller is consistent and improved in comparison to traditional P&O controller. However, the disadvantages of P&O controller is that it has very poor dynamic response and the operating point keeps fluctuating around the maximum power point during steady state operation. So in this paper the emphasis is given to the fuzzy logic controller design and a comparison is made between fuzzy logic controller and P&O controller. The algorithm implemented here was used to track the maximum power of a day. The implementation used a fuzzy logic controller and a DC-DC converter is used to maintain the PV output power at the highest level all the time. All the results are simulated using MATLAB/SIMULINK.

**Keywords:** *Maximum power point tracking, Boost Converter, Perturbation and observation, fuzzy controller*

## 1. INTRODUCTION

The electric energy produced by the PV array can be utilized in the best way by delivering it directly to utility grid, without using storage system (battery banks). The performance analysis of newly developed systems requires mathematical functional models for PV module research. Field professionals do not readily adopt these developed systems for minimising failure rate. Therefore, it requires simplified Simulink modelling of PV module for analysis purpose. In the literature basic structure of single diode PV system have been represented. For adjusting the  $I$ - $V$  curve by using artificial intelligence some authors have put forward some indirect methods. Although interesting but these methods are complex, inapplicable and needs more calculation. Modelling was confined to PV module characteristics simulation in all the above. The mathematical expressions determining the PV module (as well as PV cell) are also represented. For each expression, Simulink model is represented with numerical results for constant irradiation values ( $1000\text{W}/\text{m}^2$ ) and temperature.

When building a new photovoltaic power system it is very important to consider maximum power point tracking (MPPT) as it is required for extraction of maximum power output from a PV array under varying atmospheric conditions for maximum power output. Many researchers and industry delegates from all over the world have developed several MPPT algorithms. Some of these algorithm like perturbation and observation(P&O) method, fuzzy logic control method, linear approximation method, incremental conductance method, voltage feedback method, hill climbing method, actual measurement method and so on. Appropriate MPPT method along with good weather conditions is required for implementing maximum performance of a photovoltaic system. This paper mainly focuses on studying and comparing execution efficiency, advantages, disadvantages for two power-feedback type MPPT methods, including perturbation & observation (P&O) and fuzzy logic (FL) methods.

## 2. LITERATURE SURVEY

### 2.1 Viability analysis on photovoltaic configurations

This paper investigates, from techno-economical and environmental points of view, the feasible sites in Egypt to build a 10 MW PV-grid connected power plant. Available PV-modules are assessed and a module is selected for this study. The long-term meteorological parameters for each of the 29 considered sites in Egypt from NASA renewable energy resource website (Surface meteorology and Solar Energy) are collected and analyzed in order to study the behaviors of solar radiations, sunshine duration, air temperature, and humidity over Egypt, and also to determine the compatibility of the meteorological parameters in Egypt with the safety operating conditions (SOC) of PV-modules. The project viability analysis is performed using RET Screen version 4.0 software through electric energy production analysis, financial analysis, and GHG emission analysis. The study show that placement of the proposed 10 MW PV-grid connected power plant at Wahat Kharga site offers the highest profitability, energy production, and GHG emission reduction. The lowest profitability and energy production values are offered at Safaga site.

## 2.2 MPPT with Asymmetric Fuzzy Control for Photovoltaic System

The output power of photovoltaic (PV) module is the function of module temperature and solar insolation, so it is necessary to track maximum power point (MPP) all the time. Among of presented MPPT methods, perturbation and observation (P&O) method has drawn more attractions due to its simple and high efficiency. However the PV module

works around MPP, the output power of PV module will oscillate around it. The characteristics of PV module which are discussed in detail, show different features of MPP sides is the reason of power oscillation. A novel asymmetric fuzzy control method, which adjusts the perturbation step according to the PV module work, is presented to reduce the power oscillation. Experimental results show the presented method can track MPP rapidly under solar insolation changing and reduce remarkable power oscillation.

## 2.3A Neural Fuzzy Based Maximum Power Point Tracker for a Photovoltaic System

The global electrical energy consumption is steadily rising and therefore there is need to increase the power generation capacity. The required capacity increase can be based on renewable energy. Photovoltaic energy remains a largely unexploited renewable energy source due to low conversion efficiency of the photovoltaic modules. To maximize the power derived from the PV systems it is important to operate the panel at its optimal power point by use of a maximum power point tracker (MPPT). MPPTs find and maintain operation at the maximum power point, using an MPPT algorithm. This paper presents a high performance tracking of maximum power delivered from photovoltaic systems using adaptive neural fuzzy inference systems (ANFIS). This method combines the learning abilities of artificial neural networks and the ability of fuzzy logic to handle imprecise data. It is therefore able to handle non linear and time varying problems hence making it suitable for this work. It is expected that this method will be able to accurately track the maximum power point. This will ensure efficient use of PV systems and therefore leading to reduced cost of electricity. The performance of the proposed method was compared to that of a fuzzy logic based MPPT to demonstrate its effectiveness over other previously used MPPT techniques

## 3. PV MAXIMUM POWER EXTRACTIONS SYSTEM DESIGN

The PV module output power changes significantly as there is variation in irradiation and temperature. To extract the maximum power of from solar photovoltaic module and transfer this power to the load, the maximum power point (MPPT) algorithm is used. To transfer the maximum power of the PV module to the load, a DC-DC converter is used as shown in Figure, which acts as an interface between the load and the module. Here, step up/step down type DC-DC Converter is used. The load impedance as seen from source side is changed by varying the duty cycle of PWM control signal and hence it coincides with the maximum power point of the source to transfer the maximum power.

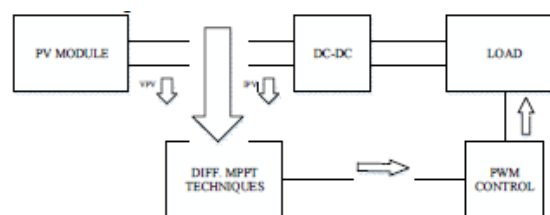

Fig.1 Block diagram of the DC-DC converter for MPP operation

## 4. DESIGN OF (P&O) MPPT

It is widely used method. Minimum sensors are used in this method. In this method, sampling of operating voltage is done and operating voltage is changed in a specific direction by using algorithm and therefore it samples  $dp/dv$ . The algorithm increases the voltage value towards MPP until  $dp/dv$  is negative if  $dp/dv$  is positive. This iteration continues until the algorithm arrives at MPP. When there is a large variation in solar irradiation then this algorithm is not suitable. The voltage perturbs around the maximum power point (MPP) and never actually reaches an exact value.

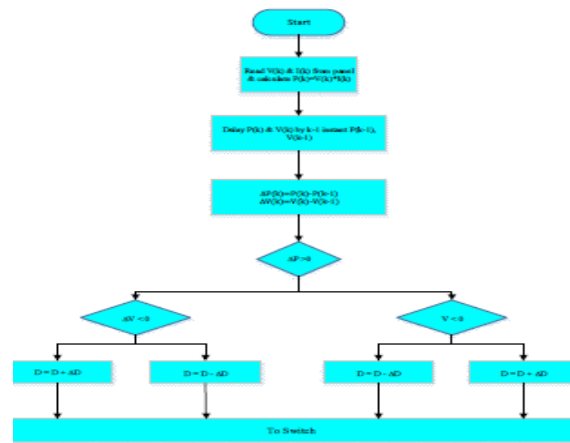

Fig.2 MPPT flowchart

5. FUZZY LOGIC METHOD

Fuzzy logic is a dynamic control method. It is recognized by multivariable consideration and multi-rules-based resolution. Over the last decade Fuzzy MPPT is very much popular. Working with inaccurate inputs, the ability to handle non-linearity and not having a precise mathematical model are some of the advantages of fuzzy logic controllers. The Fuzzy MPPT flow chart is represented in Fig and proposed Fuzzy MPPT Simulink model is represented in Fig. It consists of two inputs and, one output. Error (E) and change of error (CE) are two FLC input variables. Duty cycle (D) is output variable. So fuzzy control algorithm have the ability to improve the tracking performance for both linear and nonlinear loads as compared with the classical methods. As fuzzy logic does not use complex mathematical equation therefore it is also appropriate for nonlinear control. Figure represents the block diagram of fuzzy logic controller (FLC). The shape of membership functions of the rule base is one of the factor on which the behaviour of a FLC depends

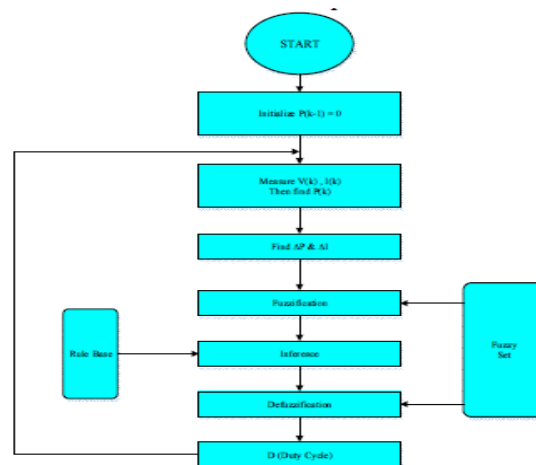

Fig.3 Flowchart of the proposed FLC method

6. RESULTS OF SIMULATION

The proposed model of Fuzzy MPPT based solar PV system is realized in the MATLAB SIMULINK environment which is represented in Fig. Here a comparison has been made with traditional P&O technique and fuzzy MPPT technique under the operating conditions, accepting constant temperature and an isolation of 1000 W/m<sup>2</sup>. In P&O technique, the incremental current step size uses the appropriate value that is processed by trial and error technique. Current control and FLC are two important parts of MPPT control which is represented in Fig.

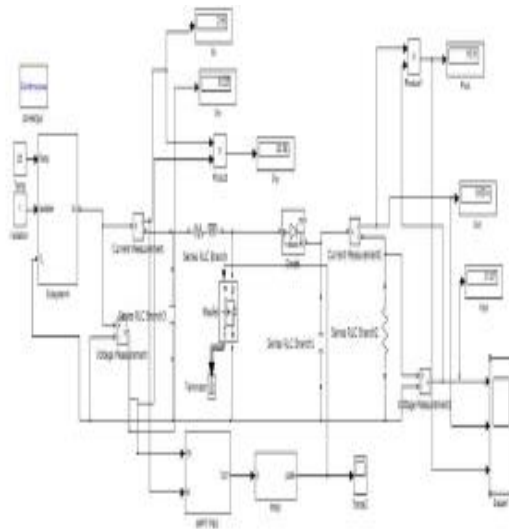

Fig.4 Simulation of P&O MPPT

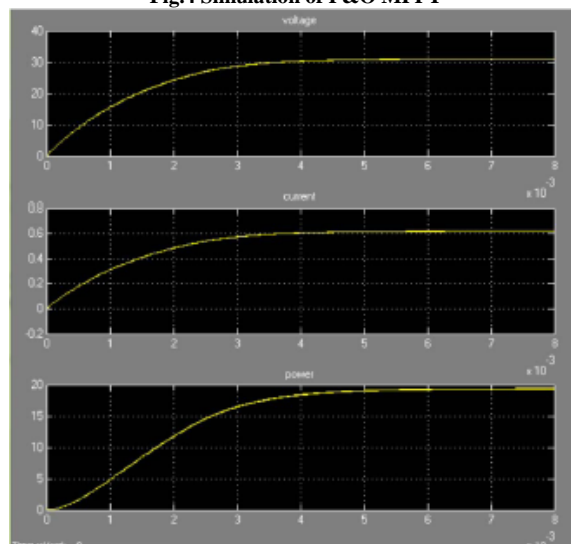

Fig.5 Result of P&O MPPT

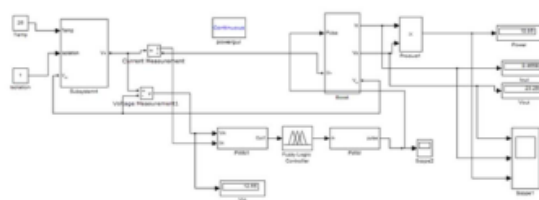

Fig. 6 Simulink model of Fuzzy logic MPPT

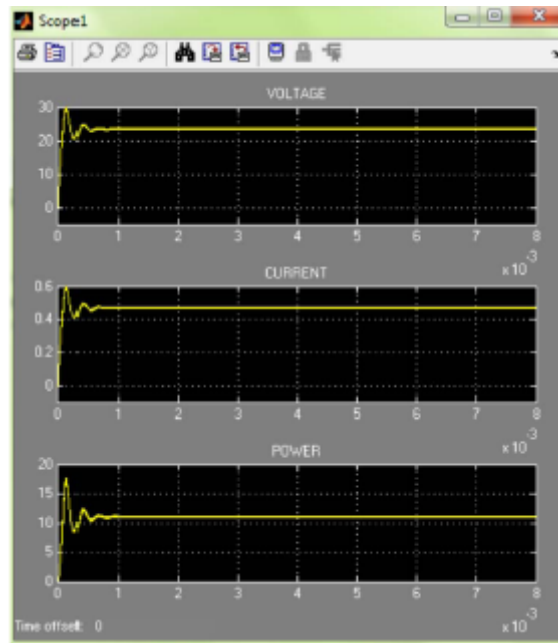

Fig.7 Result of Fuzzy MPPT

TABLE II. COMPARISON BETWEEN DIFFERENT MPPT SYSTEMS

Different MPPT system	Simulation run time 8 msec					
	V <sub>in</sub>	I <sub>in</sub>	P <sub>in</sub>	V <sub>op</sub>	I <sub>op</sub>	P <sub>op</sub>
P & O	12.4	2.55	30.8	29.8	0.65	17.88
FUZZY	12.4	2.55	30.8	24.2	0.51	12.35

**CONCLUSION:**

The proposed method of MPPT is faster in comparison to conventional P&O method when parameters like output voltage, output current and efficiency are compared. From Table II it is clear that the system performance can be improved by proposed MPPT technique using fuzzy logic. The proposed technique can be implemented in the real PV system for future work.

**REFERENCES**

[1] N. Pandiarajan and R. Moth, "Viability analysis on photovoltaic configurations", Proceedings of the IEEE Region 10 Conference (TENCON '08), Hyderabad, India, November 2008.

[2] "PV Balance of Systems Conference Berlin, Germany," June 2011, <http://www.PVinsider.com/>.

[3] Chao Zhang, Dean Zhao, "MPPT with Asymmetric Fuzzy Control for Photovoltaic System", IEEE Africon, 2009.

[4] Christopher A. Otieno, George N. Nyakoe, Cyrus W. Wekesa, "A Neural Fuzzy Based Maximum Power Point Tracker for a Photovoltaic System", IEEE African, September 2009.

[5] Neural network in maximum power point tracker for PV systems", Science Direct Electric Power Systems Research, July 2010, pp.43–50.

[6] Mohamed Azab, "A New Maximum Power Point Tracking for Photovoltaic Systems", World Academy of Science, Engineering and Technology, Vol. 34, October 2008.

[7] Larbes, S.M. Aït Cheikh\*, T. Obeidi, A. Zerguerras, "Genetic algorithms optimized fuzzy logic control for the maximum power point tracking in photovoltaic system", Science Direct Renewable Energy 34, January 2009, pp.2093-2100.

[8] Cheikh M. S. A., Larbes C., Kebir G. F. T. and Zerguerras A., "Maximum power point tracking using a fuzzy logic control scheme", Revue des Energies Renouvelables, Vol. 10, No. 32, September 2007, pp. 387 – 395.